

The BUCK PUMPS

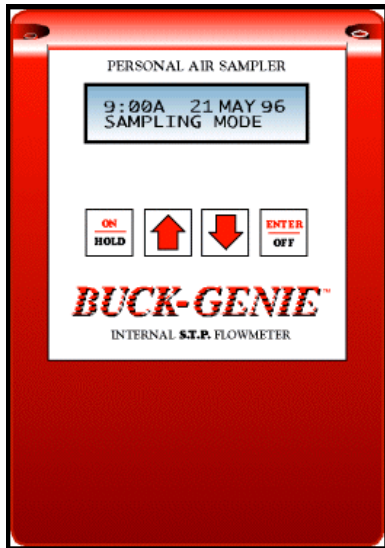

The BUCK-GENIE PUMP™

The BUCK-GENIE EXTRA™

The BUCK-GENIE LO-FLO™

Instruction Manual

BUCK
A BUCK PUMP

7101 PRESIDENTS DRIVE, SUITE 110
ORLANDO, FL 32809

Phone 407-851-8602 • Fax 407-851-8910
E-Mail: apbuck @ apbuck.com • Web site: <http://www.apbuck.com>

Table of

Contents

Section 1	Pump Operating Features.....	1
Section 2	Quick Guide To Sampling.....	7
Section 3	Timing Routines.....	11
Section 4	Configure Menus.....	15
Section 5	Bubbler and Impinger Sampling.....	20
Section 6	Gas Bag Filling.....	21
Section 7	Low Flow Sampling.....	22
Section 8	Battery Chargers.....	23
Appendix.....	Helpful Hints and Tips.....	25
 BUCK-GENIE PUMP SERIES Main Menus.....	28
 Configure Menus.....	29
 Sampling Control Logic.....	30
 Timing Routines of Genie Series of Pumps.....	31
 Sample of Pump History Report.....	32
 Run Times by Filter Type.....	33
 Parts & Accessories.....	36
 Warranty & Service Information.....	38

Pump Operating Features

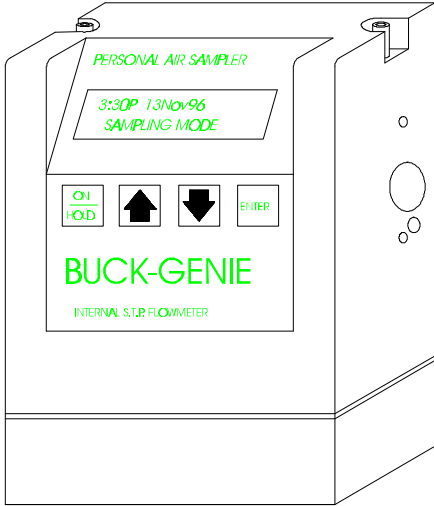

The purpose of these battery-operated sampling PUMPS is to draw contaminants from the air onto sampling media such as adsorbent sample tubes, filters, impingers, gas sample bags, or long-duration color detector tubes. The analytical method and the type of contaminants being sampled determine the selection of sampling media. Many sampling methods specify the use of filters for collection. The pore size, diameter, and filter material affect the ability of the pump to draw air onto the filter for collection. The capabilities of each Model is presented in the Appendix of this Manual.

The **BUCK-GENIE™** Constant Flow range is 800 to 5,000 cc/min. The **BUCK-GENIE EXTRA™** has a Constant Flow range of 2 to 12 LPM. The **BUCK-GENIE LO-FLO™** has a constant flow of 75-600 cc/m.

All pumps have internal sensors which provide accurate flow selection by keypad adjustment. Although the constant flow system has an accuracy of $\pm 3\%$ of any display, good practice is to verify the flow against a primary gas flow calibrator such as *The mini-BUCK Calibrator™*. Verification of flow should be conducted at intervals consistent with the user's standards.

The **BUCK-GENIE™** and the **BUCK-GENIE EXTRA™** can operate at lower vacuum flows of 5 to 800 cc/m by operating in Constant Pressure Mode and using the Universal Low Flow Holder (P.N. 109030). Flows of 5 to 80 cc/m are performed with a Low Flow Holder (P.N. 109033) in Constant Pressure Mode for the LO-FLO pump

These pumps are designed to collect air samples using accepted industrial hygiene principles and techniques. The BUCK PUMPS assure the highest degree of reliable end of day samples and incorporate unique features. A 16 bit microprocessor controls the pump's digital flow and volume calculations.

To better observe the following equipment definitions, see the Appendix for the Flow Charts of the various displays and information on the pump's operation.

MODELS AVAILABLE	
PUMP TYPE FLOW RANGE	PUMP LABEL
GENIE PUMP 5 to 5000 cc/m	BUCK-GENIE™ P.N. APB-925000
GENIE EXTRA PUMP 2 TO 12 LPM	BUCK-GENIE EXTRA™ P.N. APB-926000
GENIE LO-FLO PUMP 5 TO 600 cc/m	BUCK-GENIE LO-FLO™ P.N. APB-928000

Pump Operating Features

- **DISPLAY:** A 16-digit, 2-line alpha/numeric LCD displays the PUMP operation and programming. In general, the top line indicates PUMP information with the second line for information requiring a response from the user on the status of the PUMP. Some displays scroll to present complete information.

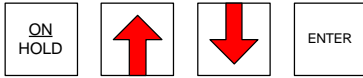

- **KEYPAD:** The four keys (ON/HOLD, ↑, ↓, ENTER) serve interactive roles. The ON/HOLD key also serves as an Escape key in sub-MENUS. The ARROW keys scroll with various menus and numbers for flow. The ARROW key also operates as a toggle switch to change commands to YES or NO. The ENTER key accepts the current display message.

- **MENUS:** A menu system provides the ability to select flow rate, clear previous data and turn pump off. Additional Menus allow Timing Routines for delayed start and auto off and type of Flow Control.

PUMP CONTROL

- **STANDARD TEMPERATURE PRESSURE (STP) FLOW SYSTEM:** The system consists of a solid state differential water pressure sensor located on the inlet suction hose and a revolution per minute (RPM) sensor on the pump. Data from these two sensors are used in flow tables established at different inches of differential pressure. By plotting the flow and RPM, a “surface of flow” can be obtained throughout the constant flow range. Sophisticated equations calculate the flow instantly and adjust the pump’s speed to match the selected flow. Accuracy of flow is ±3% of any display. It may be re-calibrated by a primary gas flow calibrator to 1% at any specified flow. Additional sensors are the absolute pressure sensor for Barometric Pressure and a temperature sensor monitoring the air discharged into the pump case. This data is used to provide STP correction for flow and volume.

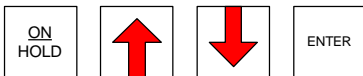
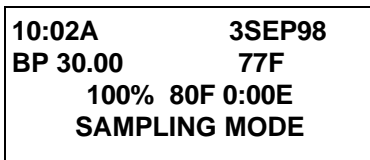

STANDARD TEMPERATURE AND PRESSURE (STP) EQUATION

Defined as 25° Celsius and 760 mm of Mercury (Hg) and calculated by the following equation:

$$\text{VOLUME (STP)} = \text{VOLUME} \times \left[\frac{P}{760 \text{ mm}} \times \frac{298^\circ \text{ K}}{T + 273^\circ \text{ K}} \right]$$

P = actual barometric pressure in millimeter of Mercury
 T = actual temperature in Celsius

Operating features (continued)

Pressure changes of less than 250 ft. in altitude are ignored. This represents 1% accuracy. Altitudes from sea level up to 10,000 ft. are corrected to STP with a sensitivity of 250 ft. increments.

Temperature changes are performed in the range of 0 to 45 degrees Celsius. The temperature readings are accurate to $\pm .5^{\circ}$ Celsius.

• **CONSTANT FLOW:** The BUCK-GENIE has three flow control modes to select. They are as follows:

- Constant Volumetric Flow Mode
- Constant STP Flow Mode
- Constant Pressure Mode

Constant Volumetric Flow is the most common type of flow in personal air sampling pumps. The flow is measured by a mini-BUCK Calibrator which establishes the reading based on a volume of air per unit of time. This flow is held constant by the differential sensor monitoring any change in the air flow entering the pump. Since this sensor has one side to the atmosphere the pump will maintain a constant volumetric flow at different altitudes.

Constant STP Flow could also be called mass flow because the flow is maintained to collect a certain mass of air over the collection period. By using the absolute pressure and temperature sensors the pump will change the flow rate accordingly. An example could be a change in altitude from sea level to 10,000 feet and temperature constant at 77F, a flow 2,000 cc/m would change to 3,000 cc/m.

• Constant Pressure Flow is utilized by the GENIE and GENIE EXTRA pumps to collect low flow samples such as charcoal tubes. A constant pressure is selected to operate the pump in conjunction with the Low Flow Universal Adsorbent Tube Holder. Flows from 5 to 800 cc/m are pulled into the Tube Holder. When using the GENIE LO-FLO pump with constant pressure, the Low Flow Tube Holder adjusts from 5 to 80 cc/min.

• **DATA STORAGE:** STATIC RAM for memory backup saves sampling information and is independent of the PUMP battery pack. The data saved includes: elapsed time, temperature, flow rate and calculated sample volume based on actual flow rates. Additional data of Flow Interrupts, Barometric Pressure, and Temperature are stored in a Log system available to upload to a PC with the BUCK LINK computer program.

Operating features (continued)

BATTERY MONITOR: To ensure an ample power supply for the sampling period, the PUMP displays battery capacity during the sampling run time. Based on a fuel gauge approach of 0 to 100%, the capacity is displayed during sampling, and at the ENDING display. To conserve battery life, the pump will turn itself off if inadvertently turned on and no keys are touched for 5 minutes in any of the MODE displays.

During the selection of flow the upper right hand corner of the display indicates the hours of calculated sample time based on Bat: % and current drain due to the filter and flow rate being selected. To observe the calculated time left to operate the pump at the selected flow rate based on current drain, press the down arrow key during sampling run.

- **TEMPERATURE DISPLAY:** The Pump has an internal temperature sensor which averages the temperature every minute for the sampling period. The temperature range is 0 to 70°C or 32° to 158°F. It is displayed during Sampling and at Ending display. Under Configure Menu, the default to Celsius or Fahrenheit degrees is selectable by using either Metric or English

- **FLOW FAULT** consists of two different events which stop the pump. FLOW FAULT may be disabled under Configure Mode.

- **FLOW INTERRUPT (BLOCKAGE) OR FILTER OFF(HOSE OFF).** This feature monitors the PUMP's differential pressure sensor and RPM sensor. At zero differential pressure the display is FILTER OFF. At zero RPM the FLOW INTERRUPT is displayed. The flow monitoring detects hose kinking or disconnecting and filter tearing or displacement. The PUMP resumes sampling after correcting either situation. If the flow is interrupted, the PUMP attempts to restart by testing for flow every few seconds. Gradually it decreases the attempts to one every minute until the flow interruption stops or the PUMP turns off due to low battery. The filter Off feature stops the PUMP, elapse clock and changes the display to FILTER IS OFF, Press ENTER. Reattaching the filter and pressing ENTER will resume sampling. This feature functions only when in the Sampling Mode.

- **DIAGNOSTIC TESTS:** On start up, the PUMP displays pump serial number and checks for battery capacity and RAM memory.

- **FLOW ADJUSTMENT :** The PUMP flow rate is adjusted using the arrow keys in the Sampling Mode. Once the desired flow is determined, press ENTER to begin sampling . To change flow, reset under the CONFIGURE MENUS.

KEYPAD CODE LOCK SYSTEM

- **SAMPLING MODE(Keypad Lock):** Four keypad entries release the lock which stops the PUMP during sampling.

- **CONFIGURE MODE (Security Code Lock):** The PUMP uses a different set of codes to prevent entry and erasing of data. These two systems provide the security necessary to collect a valid set of sampling results. Both lock systems have the options of being activated or not. The predefined codes are not changeable.

**ATTENTION
FLOW INTERRUPT**

**FILTER OFF
PRESS ENTER**

**ARROWS TO SET FLOW
2000 cc/m**

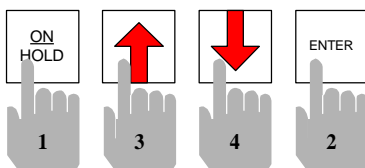
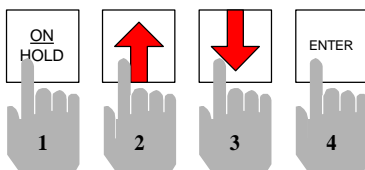

Operating features (continued)

- **BATTERY POWER:** The PUMP battery pack consists of four sub-C nickel cadmium batteries. The batteries are rated at 1800ma hour capacity. When a battery pack or PUMP with battery pack is placed in *The BUCK "Auto-Quik" Charger™*, a red light will indicate (after a 3-second delay) the cycle has begun. The charge cycle takes approximately 60 minutes. Individual packs may be charged independently. The PUMP may be left in trickle charge indefinitely. **UL** Intrinsic safe battery packs are fused and may be charged but will not be discharged by *The BUCK "Auto-Quik" Charger™*.

- **CONTINUOUS SAMPLING:** The PUMP is capable of running continuously with the battery eliminator (P.N. APB-109008) attached to the PUMP. The UL intrinsic safe models cannot use the Eliminator in hazardous areas.

DIGITAL FLOW AND VOLUME DISPLAY: The flow rate is 3% accurate of any flow display. This flow factor is based on flow determined by the differential pressure sensor and the RPM flow tables. The Volume is added to a running total of Liters every second. The volume is accurate to 10cc or 0.010 Liters. **In Constant Pressure Mode, flows entered by the user at time of calibration will be displayed as a set flow rate.**

BATT 100%	T 80F
VOL MODE	ELAPSED 00:00
0.01L	1986 cc/m

- **PUMP CASE:** The rugged polycarbonate case is highly water resistant. Inlet and outlet ports are recessed for added protection. *The BUCK "Auto-Quik"™* Battery chargers use two contacts on the battery case bottom and are also water resistant. By removing the protective cover plate on the right side of case an overnight battery charger may be connected. The battery pack must be attached to the case for overnight charging. Four self retaining screws on the bottom of the PUMP allow removal of battery pack.

- **SHIELDING FOR RFI AND EMI:** The BUCK line of digital PUMPS are inherently immune to RFI and EMI. They will meet the test criteria of other pump manufacturers with shielded cases. See Appendix for more details.

Operating features (continued)

This manual describes how *The BUCK PUMPS* operate and how to maintain them. It does not detail how to sample or analyze collected samples, or how to select methods for various airborne hazards. For this information, the best general application reference is to be found in the **NIOSH Manual for Analytical Methods** from the U.S. Government Printing Office. Additional reference sources may be found on A. P. BUCK, INC. homepage on the World Wide Web www.apbuck.com.

Quick Guide to Sampling with the BUCK GENIE PUMPS

See Appendix Section for Overview of MAIN MENUS, CONFIGURE MENUS, SAMPLING CONTROL LOGIC AND TIMING ROUTINES

Basic Information

All pumps are capable of operating in one of three modes of sampling. CONSTANT FLOW MODE is the most common method of sampling and is used for cassette filter sampling.

CONSTANT PRESSURE MODE is used to collect absorbent tube sampling with low flows and requires the Universal Low Flow Tube Holder.

STP FLOW MODE is a mass flow control using the internal Barometric Pressure and Temperature Sensors.

In CONSTANT FLOW MODE the flow is selected by adjusting the arrow keys. The flow displayed will be accurate to 3 % of the display. Pump calibration is performed under the Configure Mode and may be used to re-calibrate any specific flow to within 1 % of the reading of the pump's flow range in Constant Flow Mode. Monthly verification of the calibration is recommended.

The many features of the pumps provide flexibility to perform delayed starts and automatic stopping of sampling. The Battery Eliminator allows for sampling days at a time. The pump stores a pump run history of the sampling and a report may be printed.

For a simple Quick Start to operating the pumps the Timing Routines are Deactivated and the flow control is Constant Flow. Once the desired operation is set under the Configure Menus this becomes the default for future samplings.

THE FOLLOWING STEPS ARE TO CLEAR ANY PREVIOUS PROGRAMMING.

BP30.25" 76F
10:00A 2SEP98
BATT 100% 00:00E
SAMPLING MODE

Pressing the ON key will turn on the pump to this start-up display. The top two lines toggle information and the bottom line states the main menu selection. A full review of all the pumps main menus are presented in the Appendix Section.

VERSION 98.00
CONFIGURE MENUS

Using either arrow key advance to the CONFIGURE MENUS to begin clearing any previous programming and Deactivate the Timing Routines. Press the ENTER key to proceed with the changes and access to the sub-Menus.

The Appendix Section contains a Summary of all the sub-Menus under the Configure Menus. The following four sub-Menus are scrolled through by using the arrow key while under the Configure Menus.

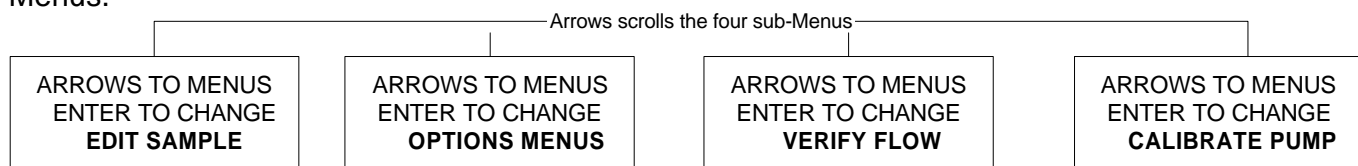

Each sub-Menu contains specific function for controlling and using the pump. The following brief explanation is provided.

ARROWS TO MENU
ENTER TO CHANGE
EDIT SAMPLE

EDIT SAMPLE menus allow for clearing all the last sampling data, the elapsed clock only or change the sampling flow rate.

ARROWS TO MENU
ENTER TO CHANGE
OPTIONS MENU

OPTIONS MENU contains the pump's clock system adjustment, selection of the three flow modes, units in English or Metric, Timing Routines, deactivation of the pump's flow fault feature, History data storage interval and the Code activation for the Security and Keypad locks.

ARROWS TO MENU
ENTER TO CHANGE
VERIFY FLOW

VERIFY FLOW is provided to measure the pumps flow rate while not advancing the elapse clock.

ARROWS TO MENU
ENTER TO CHANGE
CALIBRATE PUMP

CALIBRATE PUMP is the menu where the pump flow tables may be adjusted. Entering this menu can erase the factory calibration. To change the calibration use a Primary Gas Flow Standard such as the mini-BUCK Calibrator. Calibration of the pump sensors is not a user function and must be performed by an authorized service center.

Two menus must be entered to assure the desired configuration. First the Options Menus to deactivate the timing routines. Go to the Edit Menu to clear any previous data.

Select the blinking units desired, in this case choose the English.

ARROWS TO MENU
ENTER TO CHANGE
OPTIONS MENU

Press the ENTER key to begin the sequence of display and selectable options.

4:25P 3Sep98
RESET TIME ? : NO
YES

The NO is the default. The arrow key would change to a YES and when the ENTER key is pressed the cursor will blink under the time or date to change. Continue across the display by pressing the ENTER key (acceptance of presented display). Pressing ENTER at the NO display will advance to the next display.

TIMING ROUTINES
ARE:DEACTIVATED
ACTIVATED

The blinking words DEACTIVATED or ACTIVATED signify the selection. The arrow key will change to the alternative and press ENTER to proceed.

SELECT CONTROL
OF FLOW:CONSTANT
PRESSURE

The flow controls of choice are CONSTANT or PRESSURE MODE. Select the CONSTANT and press ENTER.

SELECT VOL. OR
STP:VOLUMETRIC
S.T.P.

Select Volumetric to have flow control not in a mass flow mode.

SELECT UNITS OF
MEASURE :ENGLISH
METRIC

Select the blinking units desired, in this case choose the English.

HISTORY REPORT
LOGGING RATE:15

The Arrow keys may be used to change the rate in which logging of data is stored during a sampling period. Log storage is limited to 800. Press the ENTER key to proceed through the other Options. To print the History Report requires the cable and Adapter PN 109054. An Example of the Report is included in the Appendix.

FLOW FAULT MODE
IS: ACTIVATED
DEACTIVATED

If for some reason the Filter Off and Flow Interrupt features are needed to be Deactivated, they may be turned off at this display. Long periods of the pump continuing to draw air without a filter attached will clog the pump with dirt. Flow Interrupt, where the flow is blocked preventing the motor to turn, will cause permanent damage. The accumulated volume is not displayed when Flow Fault is Deactivated due to lack of control over flow blockage.

SECURITY CODE
FOR CONFIG: OFF
ON

Security Code ON, prevents access to the Configure Mode where sampling data is erased. The Code is not changeable. The Code is entered by pressing the pump keys in the following order while the display reads ENTER SECURITY CODE: Press ON, ENTER,UP, DOWN.

ACTIVATE KEYPAD
LOCK SYSTEM: OFF
ON

Keypad lock prevents the pump from accidentally being stopped during a sampling period if the HOLD key was touched. It's code is ON, UP, DOWN, ENTER.

Go to the Edit Menu to clear any previous data.

ARROWS TO MENUS
ENTER TO CHANGE
EDIT SAMPLE

EDIT SAMPLE menus allow for clearing all the last sampling data, the elapsed clock only or change the sampling flow rate.

SAMPLING DATA
CLEARED?: NO
YES

To clear all elapsed time, volume and flow rate.
Select YES and proceed by pressing ENTER.

CLEARED ELAPSED
TIME ONLY?: NO
YES

Clears only elapsed time and volume.

CHANGE FLOW
RATE?: NO
YES

Changes the flow rate without changing the elapsed time and volume.

This completes the configuring of the pump to begin a sampling in Constant Volumetric Flow with no timing routines.

**BP30.25" T 76F
10:00A 2Sep98
BATT 100% 00:00E
SAMPLING MODE**

Return to the SAMPLING MODE to select the desired flow with a sampling cassette filter holder attach.

**DP: 4.50" 9:20HR
ARROWS TO SET
VOL FLOW 2010cc/m**

Use the arrow key to digitally select the desired flow. The top line alternates displaying the backpressure, known as Differential Pressure (DP), and "ARROWS TO SET". Based on this pressure the hours of run time left in the Battery Pack are predicted. Once the desired flow is selected press the ENTER key.

**BP30.25" T 76F
BATT 100% 00:00E
SAMPLING MODE**

Pressing the ENTER key will begin the sampling. To turn the pump off, arrow to the ENDING MODE and Quit. The pump is ready with the desired flow stored in memory.

**BATT 100% T 76F
VOL MODE ELAPSED 00.10
0.01L 2010 cc/m**

Begin Sampling

Programming with Timing Routines for the *BUCK-GENIE™ PUMP Series*

Purpose of Timing Routines:

The TIMING ROUTINES allow the following features to be programmed by the . The timing is based on an internal clock accurate to one second per day. It has its own battery backup system.

DELAY	START
2:01A	3SEP98
WILL START 8:00A	7SEP98

1. A Delayed Start and Auto Stop of sampling is set by Time, Day, Month and Year. This allows for daily sampling by entering a precise time or *none* to Start and Stop on command when user is ready. The Pump has a sleep mode and will turn ON to activate the Auto Start. Setting by Day is useful for indoor air quality sampling over extended periods using the Battery Eliminator (P.N. APB-109008) for all models of BUCK PUMPS.
2. ON/OFF 5min/hr. cycle feature allows the sampling to stop for 5-55 minute intervals each hour of sampling. This allows for reduced filter plugging but still gives a full 8 hr Time Weighted Average (TWA) with only 4 hours of sampling (every other cycle is off in this statement).

Y=ON N=OFF / HR
YYYYYYYYYYYY / HR

Operation of Timing Routines

Each of the pump's MODE's plays a roll in using the ROUTINES.

CONFIGURE MENUS/OPTIONS MODE

Allows the option of Timing Routines to be ON or OFF. When selected to DEACTIVATED, no displays associated with timing will appear. The System Internal Clock is set under CONFIGURE MENUS. To modify a Timing Routine after sampling has started, return to CONFIGURE MENU/EDIT SAMPLE to change.

TIMING ROUTINES ARE: DEACTIVATED ACTIVATED
--

DURATION TYPE of time will make the pump run until the time is completed. If the pump is stopped for any reason, the Duration Time will continue until it matches the elapsed time the pump actually ran.

SELECT TIMING TYPE DURATION START/STOP
--

START/STOP is enter at specific time and date. The pump will awake from the off condition to begin the sampling.

SAMPLING MODE

The programming of the START, CYCLES and STOP displays appear after setting the pump flow rate. The option to put in NO for each, gives the user the ability to start and stop on their command if no times are entered.

BEGIN PROGRAMMING PUMP WITH TIMING ROUTINE

10:00A	3SEP98
BP 30.25"	76F
BATT 100%	00:00E
SAMPLING MODE	

Top line will alternately display Time and Date with Batt. %, Temp, Elapsed Time. Also displayed is current Barometric Pressure and Temperature. Press arrows to scroll to other MODES or ENTER to begin setting the pump to SAMPLE.

DP:5.00"	8:00HR
ARROWS TO SET	
FLOW: 2000CC/M	

This display will appear only if all data has been cleared under the CONFIGURE MENUS/EDIT SAMPLE. The alternating top line display equals the Differential Pressure (DP) across the filter media being used. The hours (HR) indicate the approximate sampling time that can be achieved at this flow rate with this amount of DP. **NOTE: Increased DP's increase battery current and shortens the estimated run time. Filter plugging during sampling can severely reduce the run time.**

These next displays will appear only if Timing Routines are Selected to be Activated Under Configure Menu.

SET START TIME
YES OR NO?: YES

Press ENTER or use arrows to change to NO if no start time is desired. Once sampling has started, the PUMP'S System Time is entered as the START TIME automatically.

ENTER	START	TIME
10:29A		3SEP98
08:00A		3SEP98

This display defaults to 8:00A blinking to allow setting in comparison to the PUMP SYSTEM TIME being displayed on the top line.

Arrows scroll up or down through all times, and days, month, year. ENTER Key advances the blinking display. The ON / HOLD key will back up blinking digits for revision.

**ON/OFF 5 min / hr
USE CYCLE?: NO**

This display is the opportunity to have the pump cycle OFF and ON at 5 minute intervals during each hour. Change to YES will give the following display.

**Y=ON N=OFF / HR
YYYYYYYYYYYY / HR**

There are 12 Y's each representing 5 minutes (12x5) the equivalent of 60 minutes / hour. The Arrow Keys change each 5 min. to N (no) for OFF or Y (yes) for ON at each 5 min. interval. ENTER Key advances across the 12, 5 minute intervals. ON / HOLD KEY back up the blinking Y or N.

**SET STOP TIME
YES OR NO?: YES**

Press ENTER to set desired time for pump to STOP and turn off. Change to NO will cause the pump to sample until turned off by the user or the batteries are depleted.

**10:00A 3SEP98
BP 30.25" 76F
BATT 100% 00:00E
SAMPLING MODE**

After programming the Sampling Mode appears. The user may arrow to END Mode to turn pump off or press ENTER to continue with Sampling.

**DELAY START
2:01A 3SEP98
WILL START 8:00A 4SEP98**

This display will appear when a delayed start time was set. If no time was entered "PRESS ENTER" will appear with the top line alternately displaying the pump system time. The system time is read in as the Start Time when the ENTER key is pressed and Sampling Starts.

The next display will appear if DURATION TIME was selected under the CONFIGURE MENU/TIMING ROUTINE/ACTIVATED/DURATION.

**ENTER DURATION
000:00 HR:MIN**

Enter the desired sampling time by using the arrows at the blinking cursor and press ENTER to advance across the display.

**BP 30.25" T 76F
BATT 100% 00:00E
SAMPLING MODE**

The next display allows the pump to be advanced to ENDING MODE and turned off.

**7:47A 3SEP98
READY TO START
80% 69F 0.11E
PRESS ENTER**

If ENTER is pressed this display appears allowing the user the opportunity to press HOLD before the time starts.

**BATT 100% T 77F
VOL MODE ELAPSED 00:10
0.01L 2010 cc/m**

Begin Sampling.

**7:52A 3SEP98
TEST COMPLETED
STOP TIME WAS: 8:47A 3SEP98**

After the time has finished, this is the display.

INSTRUCTIONS FOR CONFIGURE MENUS AND ENDING MODE

10:00A 3SEP98
BP 30.25" T 76F
BATT 100% 00:00E
SAMPLING MODE

Turn on the pump. This display will appear.
Down arrow to CONFIGURE MENU.

VERSION 98.00
CONFIGURE MODE

Enter CONFIGURE MENUS by pressing ENTER. (If the Security Code for Configure Menus is ON the next display will appear, if not the CLEAR ELAPSED TIME display will appear.)

ENTER SECURITY
CODE TO PROCEED

If Security Code is ON, the display will look like this.

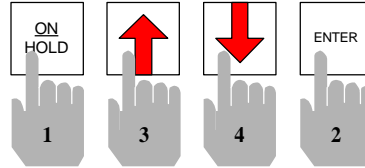

Code sequence

ARROWS TO MENUS
ENTER TO CHANGE
EDIT SAMPLE

This is the first of four menus under the CONFIGURE MENUS. By pressing the UP arrow key, they will scroll to CALIBRATE PUMP, VERIFY PROGRAM, OPTIONS MODE and EDIT SAMPLE. Pressing ENTER will begin the following selectable features in EDIT SAMPLE.

SAMPLING DATA
CLEARED? : NO
 YES

Press arrow key to YES, and then press ENTER. ***This clears all Preprogrammed settings if desired. Leave NO if only certain setting need to be reset.***

CLEARED ELAPSED
TIME ONLY? : NO
 YES

Leave at NO by pressing ENTER or YES by pressing an arrow key.
This function only erases the elapsed time, average temperature, and true volume.

CHANGE FLOW
RATE? : NO
 YES

YES will allow a new flow rate to be selected.

**RESET TIMING
ROUTINES ONLY: NO**

This display will appear only if TIMING ROUTINE is ACTIVATED under CONFIGURE MENUS/OPTIONS MODE. Change to YES will allow a change to pre-programmed STARTS, CYCLES, and STOP.

**ARROWS TO MENUS
ENTER TO CHANGE
OPTIONS MENUS**

OPTIONS MODE allows pump features to be set to a user's preference. These features will stay in the mode selected even when all data is cleared under EDIT SAMPLE.

Press ENTER for the following displays:

**4:25P 03SEP98
RESET TIME?: NO
YES**

This display is the Pump System Clock. If time is correct leave at NO. To adjust change to YES.

UNDERLINED DIGITS INDICATE BLINKING TEXT

**4:25P 3SEP98
4:25P 3SEP98**

To adjust time use the arrow keys to change. ENTER key will advance across the display for hours, minutes, day, month, and year. The ON / HOLD key will move blinking cursor back for correcting previous selections.

**TIMING ROUTINES
ARE: DEACTIVATED
ACTIVATED**

Use ARROW keys to select. When DEACTIVATED, no displays relating the START TIMES, CYCLES PER HOUR or STOP TIMES will appear.

SELECTING CONTROL OF FLOW

**SELECT CONTROL
OF FLOW: PRESSURE
CONSTANT**

PRESSURE is used with the Low Flow Tube Holder for flows below 800 cc/m.

Selecting CONSTANT FLOW would give the following display.

**SELECT VOL. OR
STP: VOLUMETRIC
S.T.P.**

Select CONSTANT VOLUMETRIC FLOW to maintain a constant flow rate at any altitude or temperature.

Select CONSTANT STP FLOW to vary the flow as the altitude and temperature fluctuate.

STP is defined as 29.90 inches of mercury and 77 degrees Fahrenheit.

SELECT UNITS OF MEASURE: ENGLISH METRIC

The units of pressure and temperature are changed.

METRIC

ENGLISH

DP = mm of Water Pressure = inches of Water Pressure

BP= mm of Mercury = inches of Mercury Pressure

Temperature = Celsius Degrees = Fahrenheit Degrees

SECURITY CODE FOR CONFIG?: YES

By leaving YES, it will prevent changing settings under CONFIGURE MENU unless the code is entered.

Code sequence

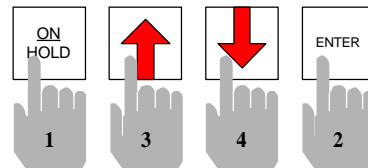

ACTIVATE KEYPAD LOCK SYSTEM?: YES

Leaving YES will leave keypad locked ON during SAMPLING. To unlock and stop pump press in sequence:

Code sequence

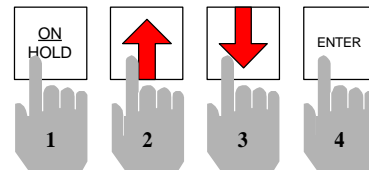

NOTE: The following event occurs depending whether YES or NO is selected. If NO is selected, the PUMP goes to HOLD when the ON/HOLD key is pressed during SAMPLING. If YES is selected to activate the keypad lock, the lock becomes active without prompting when SAMPLING MODE is entered. Keypad Lock ON during Sampling is the recommended practice. This prevents accidental touching of the HOLD Key and stopping the

ARROWS TO MENUS ENTER TO CHANGE VERIFY PROGRAM

Pressing the ENTER key will allow verifying the flow without running the ELAPSED CLOCK. If the TIMING ROUTINES are ACTIVATED under the OPTIONS MENUS, displays of START, CYCLES, and STOP are seen.

SAMPLING FLOW VERIFY?: YES NO

YES turns on the pump flowing at the same rate as in SAMPLING.

**VERIFY FLOW
0.40L 2010CC/M**

Measure Flow with external calibrator such as *The mini-BUCK CALIBRATOR*. This location is only for verification and flows cannot be changed.

**VERIFY TIMING
ROUTINES?: YES
NO**

Yes allows a review of Timing Routines setting. Change to NO and press ENTER to skip

**PROGRAMMED: START
NONE ENTERED**

The start time as initially entered under Sampling Mode. If no time was entered the Pump System Time is entered once the pump has begun to sample.

**PROGRAMMED: CYCLE
NONE ENTERED**

Cycles per hour were not selected in this example.

**PROGRAMMED: STOP
NONE ENTERED**

Display depicting no stop time was entered. Pump will run until stopped by user or batteries have been exhausted. To change STOP time once the pump is sampling go to CONFIGURE MENU/EDIT MODE.

ARROWS TO MENUS
ENTER TO CHANGE
CALIBRATE PUMP

Press ENTER to adjust the flow displayed. This location changes the internal flow tables by a factor throughout the entire operating range. Proceed only if an accurate flow reading device such as *The mini-BUCK Calibrator* is available.

WARNING: The sampling filter media must be attached to the inlet of the pump. If this menu is entered by mistake, press ON to escape or re-

CLEAR CURRENT
CALIBRATIONS?: YES
NO

If YES is chosen, the factory calibration factor is cleared to allow a new calibration. If NO is chosen, the display will go to verify the flow with current calibration.

ARROWS TO SELECT
RATE: 2000CC/M

A specific flow may be selected for this calibration change. Once the appropriate flow is displayed, press ENTER

ENTER CALIBRATOR
FLOW ???? CC/M

Use arrows to adjust the numbers to match the external flow calibrator.

Press ENTER and the correction factor will now present a flow rate matching the external flow

The following displays appear under ENDING MODE

LOG ENTRY IS 82
BP 27.90 T 77F
ENDING MODE

Top line toggles the Barometric Pressure/Temperature and LOG ENTRY IS NUMBER. The LOG-ENTRY is storage of history which occurred during its use.

Press ENTER to proceed in turning off pump.

LOG DATA is only accessible with the *BUCK LINK* software program and a PC.

55% 85F 0.10E
5.68L QUIT?: NO

Arrow key to YES and press ENTER to quit.

The top line is current battery capacity, the average temperature and elapsed time of current sample. The **L** is for the Liters(Volume) of air collected through the sampling media.

Bubbler and Impinger Sampling

SETUP:

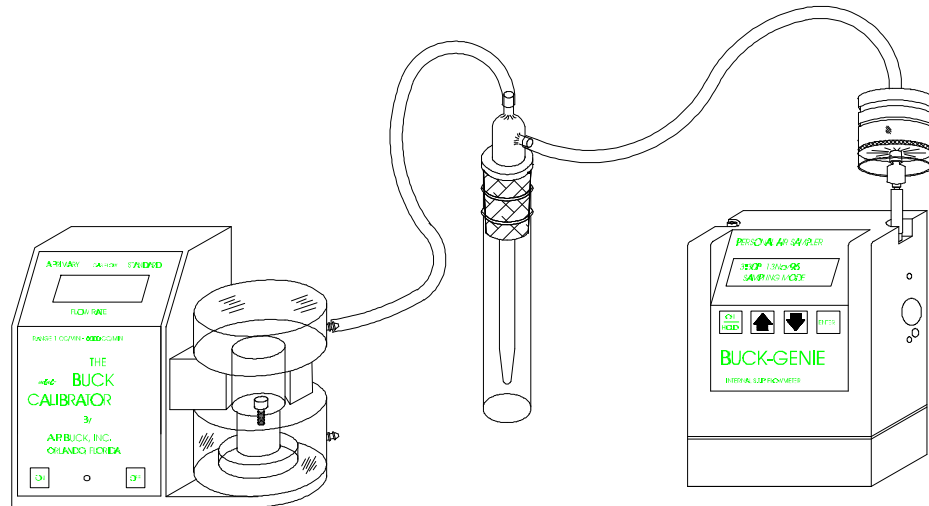

CAUTION: The default flow rate at 2000cc/m or previously selected flow may be too fast and suck the bubbler solution into the pump. FIRST SET THE FLOW WITHOUT SOLUTION IN BUBBLER.

1. Connect a standard 37mm three piece filter cassette (with a 0.8 micron filter in place) close to the inlet of the PUMP. This serves as a trap to prevent any fluids from entering the PUMP.
2. Attach a bubbler using desired length of hose to the input of the cassette, so the order of the sampling train is PUMP, cassette and then bubbler as shown in drawing.
3. Press ENTER to begin sampling. Even though different brands of bubbles have varying amounts of flow resistance, the BUCK-GENIE will flow at the pre-selected flow. By pressing the DOWN ARROW during sampling, the Differential Pressure(flow resistance) is displayed with the calculated run time of the battery pack.

Gas Bag Filling

The **BUCK-GENIE** and **BUCK-GENIE EXTRA PUMPS** can be used to fill a sampling bag. The outlet connection is connected internally to the PUMP discharge. The internal materials to which a gas sample would be exposed are: vinyl tubing, acrylic, neoprene, latex rubber, aluminum, stainless steel and BUNA-N diaphragm.

To fill a bag, remove the red vinyl cap on the left side and open the case and connect the exhaust hose to the pump mechanism nipple. Use ¼ I.D. tubing from the connector to the gas bag. A hose may be connected to the inlet of the PUMP to direct the sample into the PUMP with a standard 37mm three piece cassette (with a 0.8 micron filter in place) to provide inlet differential pressure.

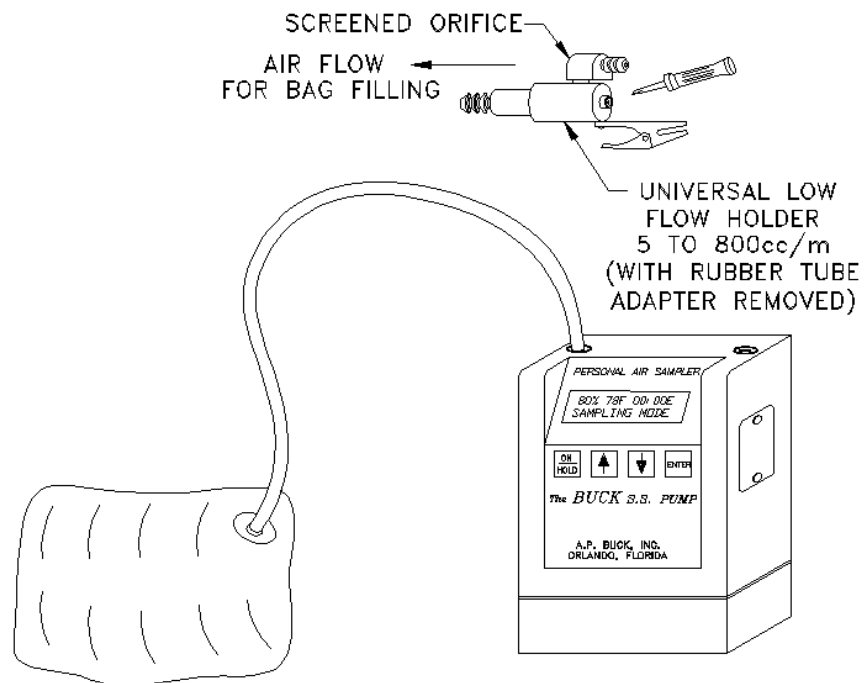

The **BUCK-GENIE PUMP** Series may be used in **CONSTANT PRESSURE MODE** to obtain low flows (less than 800 cc/m). Additional regulation of the flow will be necessary by attaching the low flow holder (P.N. APB-109030) in series with the bag. The **BUCK-GENIE** minimum flow rate is 800 cc/m in **CONSTANT FLOW MODE**.

This same process as above applies to the **GENIE LO-FLO Pump**. The Low Flow Holder (P.N. APB-109033) is used for flow below 80 cc/m.

Low Flow Sampling (5 cc/m to 800 cc/m)

Using *BUCK-GENIE* and *BUCK-GENIE EXTRA* PUMPS

SETUP:

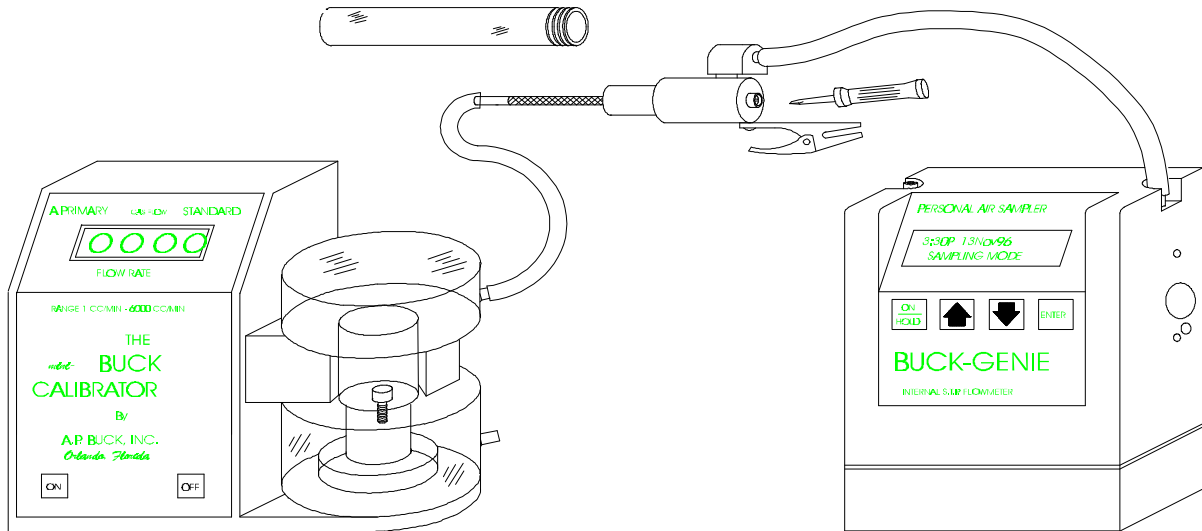

Using the setup as shown above, flows of 5 to 800 cc/m may be collected in adsorbent tubes:

- 1 The PUMP must be in CONSTANT PRESSURE MODE selectable under the CONFIGURE MENUS/OPTION MODE.
- 2 Press ENTER at the SAMPLING MODE.
- 3 The default PRESSURE of 6.0 inches of water will start the pump.
- 4 Using the calibrator measure the flow through the adsorbent tube.
- 5 Use a screw driver to adjust the flow to the desired rate. If the desired flow cannot be obtained by adjusting the needle valve in the low flow holder, on the PUMP use the arrows to increase the Pressure setting(DP). The top line is displaying the DP and hours(HR) of expected sampling time at these settings. The lower pressure give longer run times.
Some new higher flowing thermal desorption with higher backpressure tubes may be used in CONSTANT FLOW MODE with the non-adjustable tube holder (P.N. APB-109032) for this purpose.
- 6 Once the flow is appropriate, press the ENTER KEY to enter the measured flow. An accuracy of flow of $\pm 5\%$ can be maintained throughout the sampling day.

One Hour Auto-Quik™ Battery Charger

The BUCK “Auto-Quik” Charger™ and “Auto-Quik5” Charger™ are designed to charge only the battery packs for the BUCK pumps.

Description

The BUCK “Auto-Quik” Chargers are microprocessor controlled making the battery recharge process automatic. The battery pack can be recharged with or without the pump connected. When inserting the pump into the charging pocket, the two electrodes on the bottom of the pump battery pack must align with the two pins in the charging pocket. The charger uses a voltage detection technique that provides a full recharge. Red and Green “LED” lights at each pocket indicate the charge and trickle charge process. When turned on, the Red and Green LED’s blink to indicate the microprocessor is functioning and the charging pocket is operational.

The “*Auto-Quik’s* will charge a pump battery in approximately 1 hour (2 hours for *BUCK-GENIE EXTRA*). After a full charge, a trickle charge cycle (green light on) will begin. Batteries may be left in trickle charge indefinitely. After a long period (days) the green LED may blink to indicate trickle charge is OFF. Trickle charge will restart when the battery pack voltage drops.

The charger is designed to operate from a 115 VAC outlet (a 100 VAC and 220 VAC versions are available). The charger is turned on by a switch located near the power cord. A three ampere slow blow fuse serves to protect the unit.

Operation

When turned on, the POWER light will indicate red ON and the station charge and trickle lights will flash through all stations to indicate the microprocessor is functioning correctly. Place the pump into a charging pocket. After three seconds, the red LED should stop blinking and stay on. If this does not occur, lift pump out of pocket and reinsert. Repeat if necessary until red light stays ON.

When the green light turns ON and red is OFF, the batteries are fully charged. If after one hour the red light is still on, remove the pump to prevent damage. **Do not use this pocket until it is repaired.**

The pump should not be turned on during the charge process. If this happens accidentally, the pump will automatically turn itself off to prevent high voltage damage.

Note: The fast charging of the Auto-Quik Charger prevents any of the old “Memory Problem” previously associated with Nickel Cadmium batteries. The reason is improved chemistry in the cells’ electrolyte and the high current charge rate. Any stagnation of the electrolyte or electrical corrosion is removed on charging.

Standard Charger for use with all Buck Pump's

The Standard Charger is designed to charge the BUCK PUMP battery pack in 16 hours.

The connection is made through the A/C adapter, which is on the right side of the pump under the cover plate. The red LED light on the A/C charger will light. After 16 hours, the PUMP batteries will be fully recharged for portable operation. Note: The battery pack must be connected to the PUMP to charge.

The % battery capacity will not be accurate during charging. The % is only accurate where the PUMP is on and running for a period of 5 to 10 minutes. At this time the battery chemistry is providing the voltage, not a static charge on the electrodes of the battery.

Battery Eliminator

• **CONTINUOUS SAMPLING:** The PUMP is capable of running continuously with the battery eliminator (P.N. APB-109008) attached to the PUMP. The UL intrinsic safe models cannot use the Eliminator in hazardous areas.

Elapse time will count to 256 hours and XX minutes (10.6 day). At this moment, the timer will begin over at 00:00 hours.

Volume of Samples will calculate to 76800 Liters or the maximum flow of 5.0 LPM × hrs. × 60 min/hr. This is 10.6 days of sampling. The volume is displayed under the ENDING MODE Main Menu and during SAMPLING.

Appendix

Helpful Hints and Tips for Pump Operation

1. One key turn off feature is provided by pressing the ENTER key for four seconds during sampling. When the ON key is pressed, later, the pump will return to the previous turn off display. This feature will allow a worker to turn off temporarily and back on without much training on pump displays.
2. Select flow rates will remain in calibration day after day. A good practice is to verify with a primary gas flow calibrator.
5. Preprogrammed stop times can easily be extended by going into CONFIGURE MENU/EDIT SAMPLE to STOP time and change the time. See DISPLAY CHARTS for location.

RFI and EMI Shielding OF Personal Air Sampling Pumps

The concern about Radio Frequency Interface (RFI) and Electromagnetic Interference (EMI) on personal air sampling PUMP's originates from the method used to run the PUMP's direct current (DC) motor.

A problem was identified in 1988 that hand held radios could disrupt the flow control on the vast majority of PUMP's on the market. These PUMP's use "amplitude control" to maintain the PUMP's speed. The RFI would induce a spike of voltage and severely affect the PUMP's speed.

Because BUCK PUMP's are completely digitally controlled, RFI does not cause any influence on the PUMP's settings. A Pulse Width Modulation (PWM) is used to control the motor and the spikes of voltage are not induced. A comparison would be the difference in an AM radio or FM radio in a lightening storm. Amplitude Modulation (AM) and Frequency Modulation (FM) are a good analogy to this DC motor issue.

The circuit boards (C.B.) in these PUMPS have analog and digital grounds that are coupled to one internal ground plain of the four layer circuit board.

The EMI can effect relays which are usually latched ON or OFF by a DC magnetic field. A strong EMI could affect this process. The *BUCK-GENIE* PUMP's are turned ON and OFF by a solid state chip and not affected by EMI.

The BUCK line of PUMP's are basically immune to RFI and EMI under reasonable circumstances. They meet the same test criteria claimed by other manufacturers using shielded cases.

BUCK-GENIE PUMP SERIES MAIN MENU

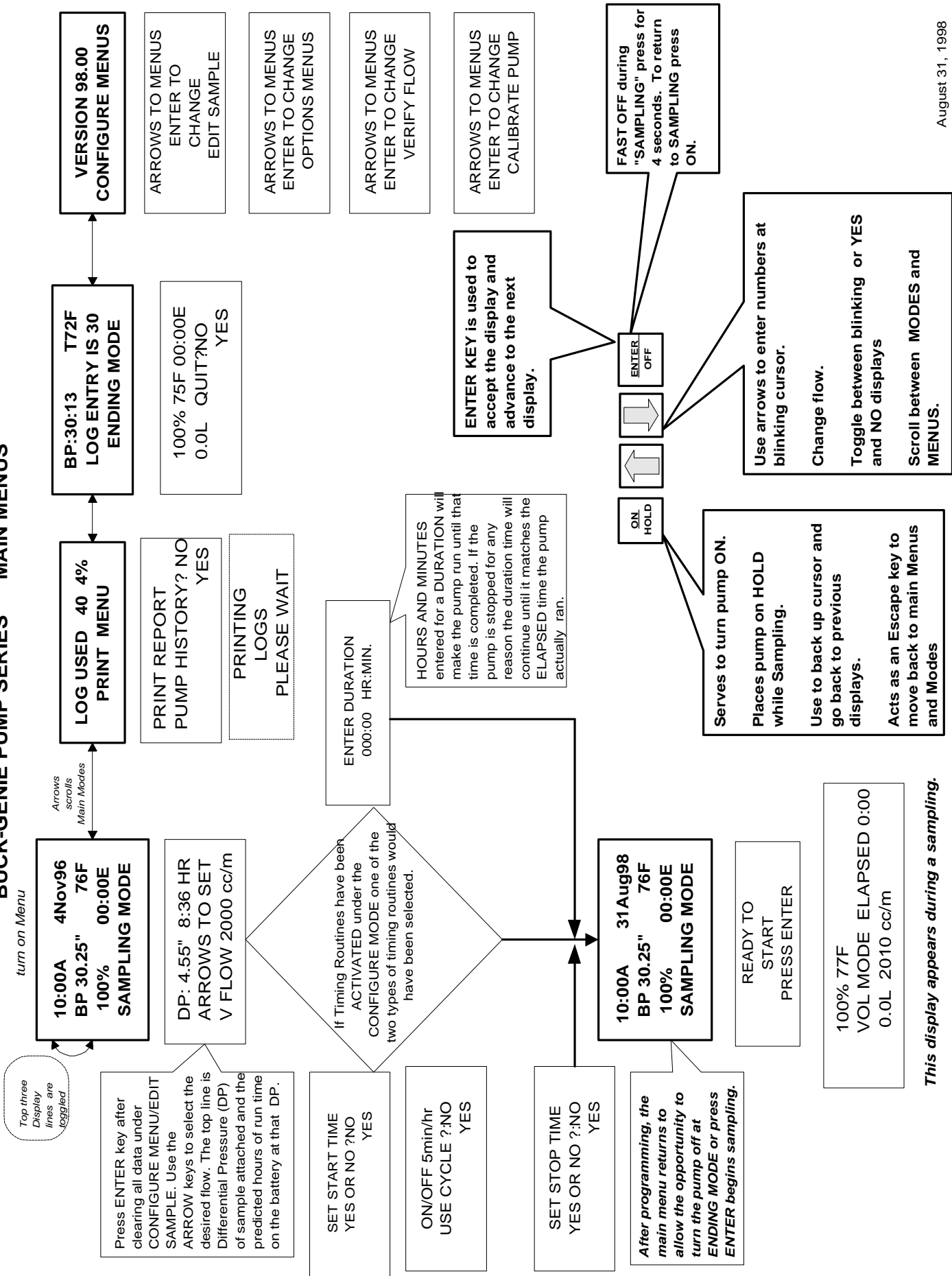

**BUCK-GENIE SERIES OF PUMP
VERSION 98.00**

**VERSION 98.00
CONFIGURE MENUS**

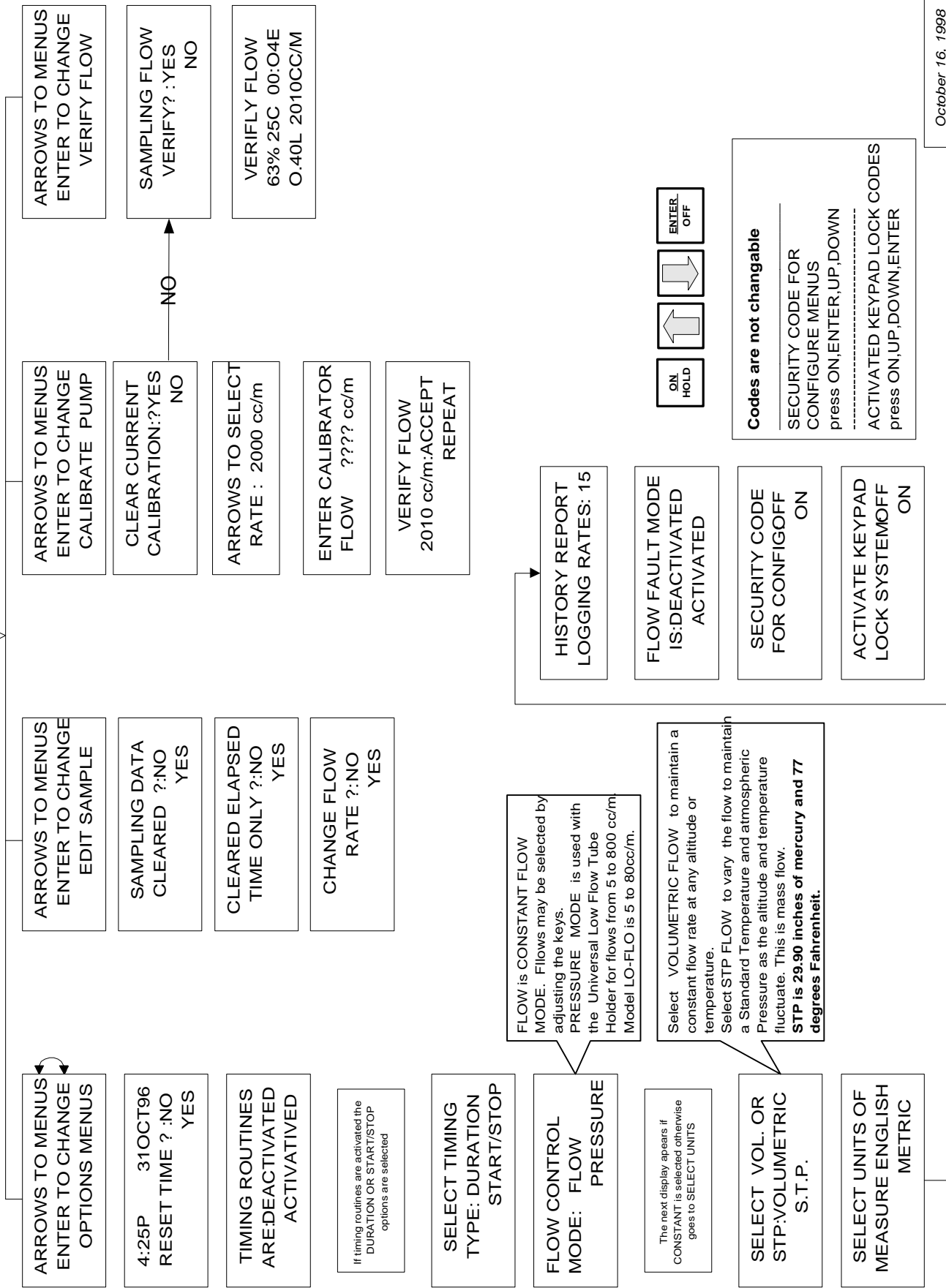

**BUCK-GENIE SERIES OF PUMPS
VERSION 98.00**

SAMPLING CONTROL LOGIC

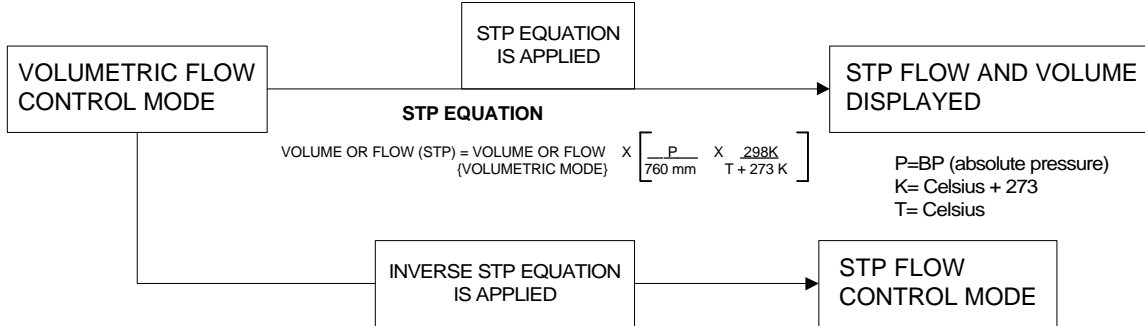

**FLOW CHARTS IN
VOLUMETRIC FLOW
AND STP FLOW MODES**

STP FLOW CONTROL = FLOW X $\left[\frac{760 \text{ mm}}{P} \times \frac{T+273\text{K}}{298\text{K}} \right]$
 (STP FLOW MODE)

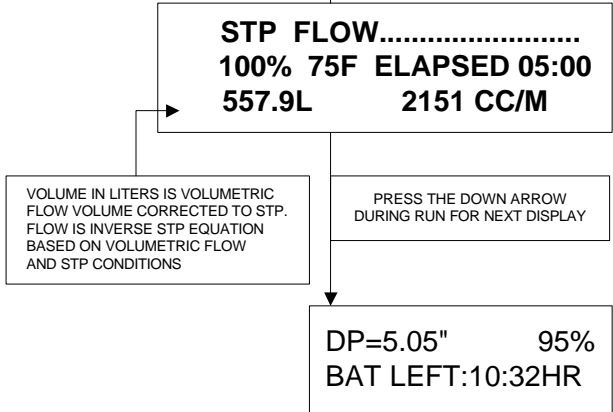
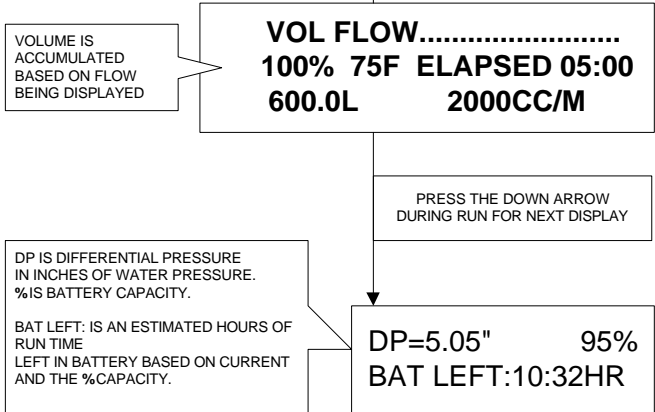
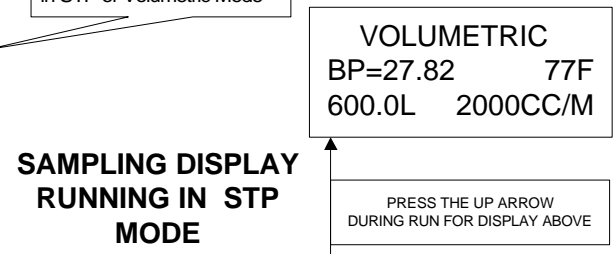
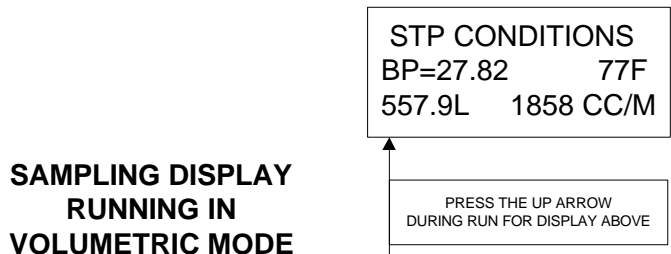
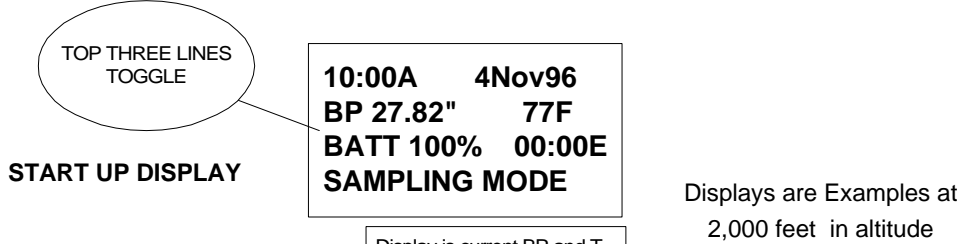

Pressure Unit Conversion Constant
 1 inch of Mercury X 25.4 =25.4 millimeters (mm)
 1 millimeter of Mercury X 0.03937 = 0.03937 inches of Mercury

Definition of STP
 English Metric
 BP = 29.90" 760 mm
 T = 77F 25C

NOV 16, 1996

TIMING ROUTINES OF GENIE SERIES OF PUMPS

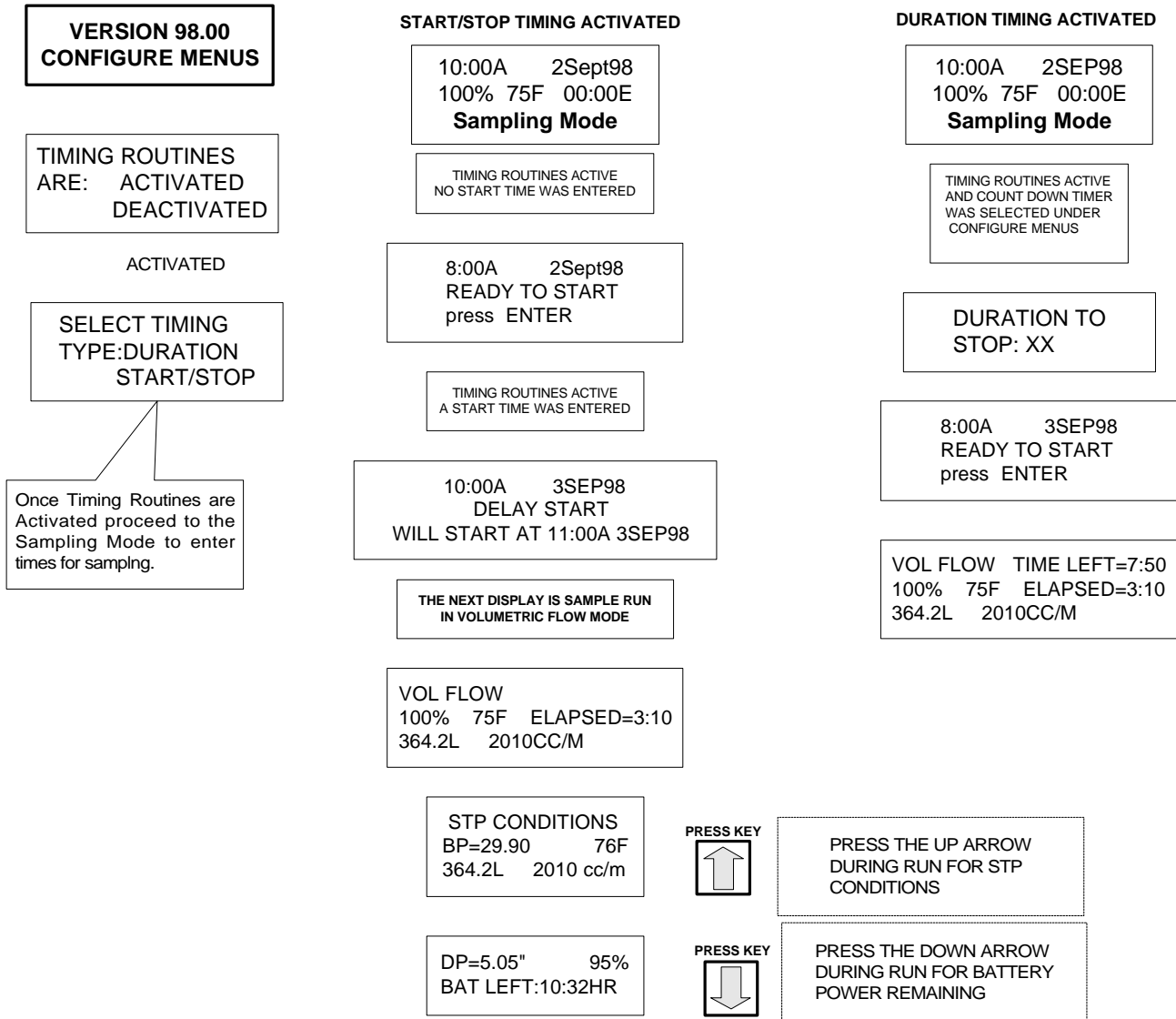

PUMP SAMPLING HISTORY REPORT

Collector: _____ Serial No: G01061
 Sampling Site: _____ Pump Type: GENIE
 Comments: _____ Report Date: 09/03/98
 Calibration: 09/03/98
 Calibrator Serial No: _____
 Sample No: _____ Lot Number _____ Cassette Size _____
 Batch Number _____ Filter Pore Size _____

Date	Time	Log Event	Elapsed Time	Vol Flow	Total Vol	Battery (STP)	DP Measd	BP Measd	Temp Val
09/03/98	03:45p	Clear Data							
05/01/98	07:01a	Power up							
05/01/98	07:01a	Clear Data							
05/01/98	07:01a	Calibration							
05/01/98	07:01a	Start Samp							
05/01/98	07:16a	Run Update	0:16	2011	30.0	0.0	100%	8.4	30.24 75
05/01/98	07:31a	Run Update	0:31	2010	60.0	0.0	100%	8.4	30.24 75
05/01/98	07:46a	Run Update	0:46	2011	90.0	0.0	100%	8.4	30.24 74
05/01/98	08:00a	Run Update	1:00	2010	120.0	0.0	90%	8.4	30.24 74
05/01/98	08:15a	Run Update	1:15	2011	150.0	0.0	90%	8.4	30.24 75
05/01/98	08:30a	Run Update	1:30	2010	180.0	0.0	90%	8.4	30.24 75
05/01/98	08:45a	Run Update	1:45	2011	210.0	0.0	90%	8.4	30.24 74
05/01/98	09:00a	Run Update	2:00	2010	240.0	0.0	80%	8.4	30.24 74
05/01/98	09:15a	Run Update	2:15	2011	270.0	0.0	80%	8.4	30.24 75
05/01/98	09:30a	Run Update	2:30	2010	300.0	0.0	80%	8.4	30.24 75
05/01/98	09:45a	Run Update	2:45	2011	330.0	0.0	80%	8.4	30.24 74
05/01/98	10:00a	Run Update	3:00	2010	360.0	0.0	70%	8.4	30.24 74
05/01/98	10:15a	Run Update	3:15	2011	390.0	0.0	70%	8.4	30.24 75
05/01/98	10:30a	Run Update	3:30	2010	420.0	0.0	70%	8.4	30.24 75
05/01/98	10:45a	Run Update	3:45	2011	450.0	0.0	70%	8.4	30.24 74
05/01/98	11:00a	Run Update	4:00	2010	480.0	0.0	60%	8.4	30.24 74
05/01/98	11:15a	Run Update	4:15	2011	510.0	0.0	60%	8.4	30.24 75
05/01/98	11:30a	Run Update	4:30	2010	540.0	0.0	60%	8.4	30.24 75
05/01/98	11:45a	Run Update	4:45	2011	570.0	0.0	60%	8.4	30.24 74
05/01/98	12:00p	Run Update	5:00	2010	600.0	0.0	50%	8.4	30.24 74
05/01/98	12:15p	Run Update	5:15	2011	630.0	0.0	50%	8.4	30.24 75
05/01/98	12:30p	Run Update	5:30	2010	660.0	0.0	50%	8.4	30.24 75
05/01/98	12:45p	Run Update	5:45	2011	690.0	0.0	50%	8.4	30.24 74
05/01/98	01:00p	Run Update	6:00	2010	720.0	0.0	40%	8.4	30.24 74
05/01/98	01:15p	Run Update	6:15	2011	750.0	0.0	40%	8.4	30.24 75
05/01/98	01:30p	Run Update	6:30	2010	780.0	0.0	40%	8.4	30.24 75
05/01/98	01:45p	Run Update	6:45	2011	810.0	0.0	40%	8.4	30.24 74
05/01/98	02:00p	Run Update	7:00	2010	840.0	0.0	30%	8.4	30.24 74
05/01/98	02:15p	Run Update	7:15	2011	870.0	0.0	30%	8.4	30.24 75
05/01/98	02:30p	Run Update	7:30	2010	900.0	0.0	30%	8.4	30.24 75
05/01/98	02:45p	Run Update	7:45	2011	930.0	0.0	30%	8.4	30.24 74
05/01/98	03:00p	Run Update	8:00	2010	960.0	0.0	20%	8.4	30.24 74
05/01/98	03:00p	Stop Samp							
05/01/98	03:00p	Power down							

The *BUCK-GENIE*[™] PUMP WITH STANDARD BATTERY PACK

TABLE OF (TYPICAL) BATTERY LIFE BY FILTER TYPE

CONSTANT FLOW MODE

FLOW RATE Liters/Minute	HOURS		HOURS	
	25 mm 0.8μ	37 mm 0.8μ	37 mm Fiber Glass	47 mm Fiber Glass
2.0	6.4	10.5	14	14
2.5	5.4	9.5	13	13
3.0	4.2	8.0	12	12
3.5		7.0	11	11.5
4.0			10	11
4.5			9	10
5.0				9.5

CONSTANT PRESSURE MODE

Inches of Water Pressure	Battery Life Flow from 5-500 cc/m
2"	12.9 hrs.
5"	11.3 hrs.
10"	9.2 hrs.
15"	7.8 hrs.
20"	6.9 hrs.
25"	6.2 hrs.

TYPICAL OPERATING RANGE OF *BUCK-GENIE* PUMP

50 inches of water pressure up to 1.9 LPM

40 inches of water pressure up to 2.3 LPM

30 inches of water pressure up to 2.7 LPM

20 inches of water pressure up to 3.3 LPM

10 inches of water pressure up to 4.0 LPM

5 inches of water pressure up to 4.5 LPM

2 inches of water pressure up to 5.0 LPM

The *BUCK-GENIE EXTRA™* PUMPS WITH STANDARD TRIPLE BATTERY PACK

TABLE OF (TYPICAL) BATTERY LIFE BY FILTER TYPE

CONSTANT FLOW MODE

FLOW RATE	HOURS		HOURS	HOURS	
	25 mm		37 mm 0.8μ	37 mm Fiber Glass	47 mm Fiber Glass
	0.45μ	0.8μ			
2.0	7.0	14	22	>24	>24
3.0	5.5	11.5	17	23	>24
4.0	9		13	18	23
5.0			11	15	19
6.0			9.5	12	15
7.0				10	13
8.0				8	11
9.0					8

OPERATING RANGE OF PUMP

- 50 inches of water pressure up to 5.7 LPM
- 40 inches of water pressure up to 6.4 LPM
- 30 inches of water pressure up to 7.2 LPM
- 20 inches of water pressure up to 8.3 LPM
- 10 inches of water pressure up to 9.7 LPM
- 5 inches of water pressure up to 10.3 LPM

The *BUCK-GENIE LO-FLO™ PUMP* WITH STANDARD BATTERY PACK

TABLE OF (TYPICAL) BATTERY LIFE

HOURS OF BATTERY LIFE

FLOW RATE	DIFFERENTIAL PRESSURE (D.P.)			
	2 INCHES	5 INCHES	10 INCHES	20 INCHES
CC/Minute				
100	13.0 hrs.	12.9 hrs.	12.3 hrs.	11.9 hrs.
200	12.5 hrs.	11.9 hrs.	11.6 hrs.	11.1 hrs.
300	11.6 hrs.	11.1 hrs.	10.9 hrs	10.0 hrs
400	11.1 hrs.	10.8 hrs.	10.4 hrs.	9.7 hrs.
500	10.0 hrs.	9.5 hrs.	9.2 hrs.	N/A
600	9.2 hrs	9.1 hrs.	N/A	N/A

PARTS LIST & ACCESSORIES

1. **The BUCK “Auto-Quik” Charger™** 115v (APB-601000), 230v (APB-601010), 100v (APB-601020)
Single Station Automatic One Hour Charge / Discharge Charger for use with the **BUCK-GENIE PUMP**.
2. **The BUCK “Auto-Quik5” Charger™** 115v (APB-605000), 230v (APB-605010), 100v (APB-6050120)
Five Station Automatic One Hour Charge / Discharge Charger for use with the **BUCK-GENIE PUMP**.
3. BUCK Standard Charger / Adapter (APB-109110)
Designed to charge the **BUCK -GENIE PUMP** battery pack in 16 hours.
4. **The BUCK “One Hour” Rechargeable Battery Pack™** for the **BUCK -GENIE PUMP** (APB-129510)
These self contained packs may be charged independently from the BUCK-GENIE PUMP™ and used as additional back up batteries in the field. Simple 4 screw changing operation.
5. BUCK “Adjustable Flow Sample Holder” (APB-109030)
Desired flow may be precisely adjusted for flows of 5cc to 800cc with **The mini- BUCK CALIBRATOR™** and a screwdriver using the built in adjustable screw.
6. Protective Cover for Adjustable Flow Holder (Sorbent sample tube size determines cover size.)
(APB-109022): NIOSH CHARCOAL; all standard 6mm O.D. × 70mm (3” in length)
(APB-109024): All 8mm O.D. × 110mm (4 5/8” in length)
(APB-109026): All 10mm O.D. × 150mm (6 1/4” in length)
(APB-109028): All 10mm O.D. × 220mm (8 15/16” in length)
7. Luer Adapter (APB-109000) (PKG. of 10)
Adapter fits outlet port on the **BUCK -GENIE PUMP** for bag filling or to connect filter to ¼” I.D. tubing.
8. Sample Hose Clip (APB-109020) (PKG. of 10)
Clothing clips for attaching hoses and sampling heads to a worker’s collar. Snap nylon strap for 3/8” O.D. hose.
9. Multi Low Flow Tube Holder (APB-109034)
Acrylic manifold allows connection of up to three low flow holders for independent multiple low flows with a single PUMP.
10. BUCK “Non-Adjustable Flow Sample Holder” (APB-109032).
11. BUCK Low Flow Holder (APB-109033) for the GENIE LO-FLO pump.

(Parts List and Accessories continued)

12. Protective PUMP Pouch (APB-109042)
Nylon carrying pouch for *The BUCK -GENIE PUMP*. Belt loop and shoulder strap are designed to protect the PUMP during sampling and for worker comfort.
13. Multi-PUMP Case (APB-109016)
Convenient carrying case designed to accommodate up to 5 PUMPs, *The BUCK "Auto-Quik" Charger™* and *The mini-BUCK CALIBRATOR™* or *The BUCK Cali-Logger™*. The design is flexible to allow variation of accessories with PUMPs.
14. Single-PUMP Case (APB-109018)
Convenient carrying case designed to accommodate 1 PUMP with accessories and Standard Charger / Adapter.
15. Communication Cable (APB-109048)
6 pin, RS-232 connectors for communication of the *BUCK -GENIE PUMP* to *The BUCK LINK™*.
16. Printer Cable and Adapter (APB-109054) for use with GENIE LO-FLO only.
17. The *BUCK-GENIE PUMP* Series Manual - (APB-105095).

WARRANTY

The seller warrants to the Purchaser that any equipment manufactured by it and bearing its name plate to be free from defects in material or workmanship, under proper and normal use and service, as follows: if, at any time within 1 year from the date of sale, the Purchaser notifies the Seller that in his opinion, the equipment is defective, and returns the equipment to the Seller's originating factory prepaid, and the Seller's inspection finds the equipment to be defective in material or workmanship, the Seller will promptly correct it by either, at its option, repairing any defective part or material or replacing it free of charge and return shipped lowest cost transportation prepaid (if Purchaser requests premium transportation, Purchaser will be billed for transportation costs). If inspection by the Seller does not disclose any defect in material or workmanship, the Seller's regular charges will apply. This warranty shall be effective only if installation and maintenance is in accordance with our instructions and written notice of a defect is given to the Seller within such period. This warranty is exclusive and is in lieu of any other warranties, written, oral or implied; specifically without limitation, there is no warranty of merchantability or fitness for any purpose. The liability of the Seller shall be limited to the repair or the replacement of materials or parts as above set forth.

LIMITATION OF LIABILITY

The seller shall not be liable for any claim for consequential loss or damage arising or alleged to have risen from any delay in delivery malfunction or failure of the equipment. The Seller's liability for any other loss or damage arising out of or connected with the manufacture, sale or use of the equipment sold, including damage due to negligence, shall not in any event exceed the price of the equipment supplied by us.

A.P. Buck, Inc. reserves the right to make changes at any time, without notice, in prices, colors, materials, specifications, and models; and to discontinue models.

COPYRIGHT PROTECTION OF DOCUMENT

Copyright© 1990, 1996 A.P. Buck, Inc.

This operating and service manual and the data enclosed herein are not to be reproduced or used, in whole or in part, by anyone without written permission of A.P. Buck, Inc.

SERVICE POLICY

For all work not covered under warranty, A.P. BUCK, INC. reserves the right to proceed with repairs up to a maximum cost of \$250 without notifying the customer. If major components must be replaced, A.P. BUCK, INC. will notify the customer before proceeding with repairs.

When the instrument(s) is returned, please include a purchase order marked "Repair-Cost Not To Exceed \$250 Without Customer Authorization." Also include name and telephone number, serial number(s), date of purchase, and description of problem.

Return to: **A.P. BUCK, INC.**
7101 PRESIDENTS DRIVE
SUITE 110
ORLANDO, FL 32809
ATTENTION: CUSTOMER SERVICE

You must obtain an **RMA** number prior to returning any product. Obtain your RMA number by calling Customer Service at **(407) 851-8602** (have your customer # ready for service). All returned products must be received within 30 days of the RMA number issuance date. Products returned late will be returned to the customer.

TECHNICAL SUPPORT SERVICES

Phone Assistance: 407-851-8602 - If calling from outside the continental USA dial local international access code first.

Fax: 407-851-8910

If you need additional information or help during installation or normal use of this product, contact *A.P. BUCK, INC.* Technical Support. Our customer support staff will attempt to answer your installation questions by phone or issue a service authorization number for repair or replacement of your product. Unauthorized returns will not be accepted.

When calling for support, please have your product serial number and product model available.

Hours: Monday - Friday.....8:00am -4:30pm
Eastern Standard Time